



SKYLO

3 PART DUAL FLUSH HEIGHT ADJUSTABLE SYPHON



WARNING

We shall not be responsible or liable for any failure of, or damage to, this plumbing product caused by the use of chlorine/bleach cleaners or related products added to the tank water. Use of such products will void the warranty and may result in product failure, possibly causing property damage. Do not over tighten plastic nuts and always turn off water supply when installing / removing toilet cistern parts.

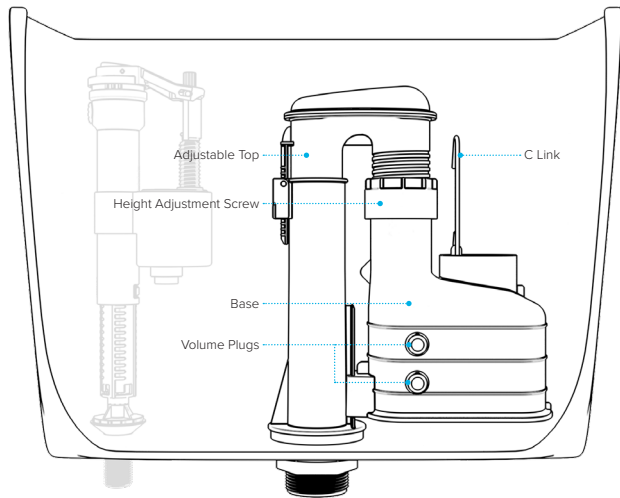

Please note: Save this instruction sheet for future reference
IMPORTANT: DO NOT use plumber's putty to seal this fitting

For more information please contact:

VIVA Sanitary
Units 1-2 Capitol Trading Park, Kirkby Bank Road
Knowsley Industrial Estate, Liverpool, L33 7SY

Tel: 0151 546 0531 Fax: 0151 549 4187
E-mail: sales@vivasanitary.co.uk

INSTALLATION INSTRUCTIONS

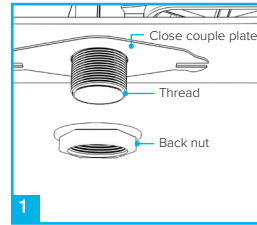

1 Insert the flush valve into the water tank. Slide close couple plate over the syphon thread and tighten to the tank using the washer and nut.

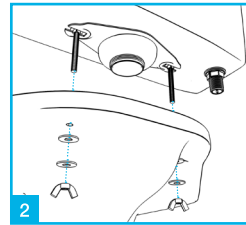

2 Fit doughnut washer and bolts and secure cistern to the pan with wingnuts.

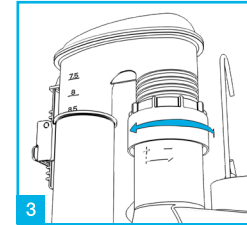

3 To adjust the height of the flush valve twist the height adjustment screw and set to the desired height.

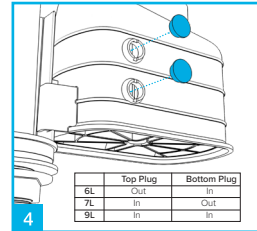

4 The flush volumes can be adjusted by removing the volume plugs. (Please refer to the guide above)

	Top Plug	Bottom Plug
6L	Out	In
7L	In	Out
9L	In	In

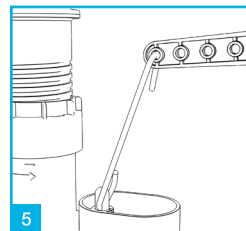

5 To operate the flush valve connect the C link to the toilet handle lever arm.

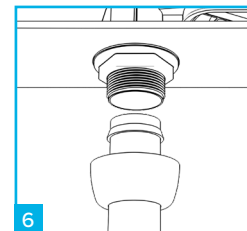

6 Low level installation does not require a close couple kit. Slide back nut and conical washer over the flush pipe and insert flush pipe into base of flush valve and secure with back nut.

Dual Flush Operation

Full Flush
(Depress and release)



Half Flush
(Depress and hold)



Operating the dual flush function is really easy, when flushing your toilet depress and release for a full flush, depress and hold for a half flush. This will only flush half the water in your tank. Saving water and money.

Internal Overflow

Water will internally overflow into the toilet pan when the water level reaches the spill over point.

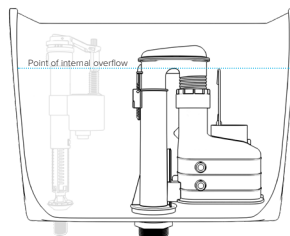

3 Part Function

The syphon can be dismantled into 3 separate parts. To remove the syphon from a cistern release the locking clip and remove the syphon from the tank.

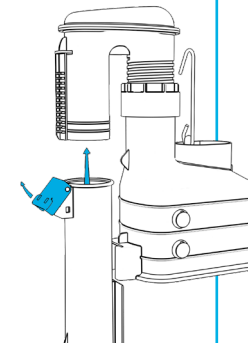

TROUBLESHOOTING

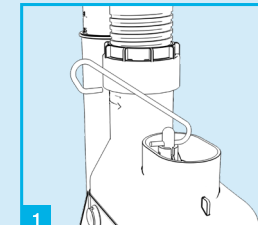

1 Remove the C link by rotating until loose.

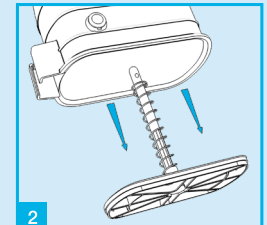

2 Slide the stem through the base to access the suction unit.

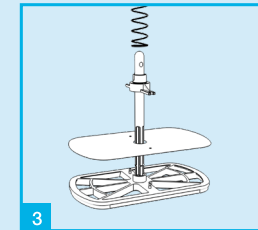

3 Remove the spring and clip then replace the diaphragm washer.

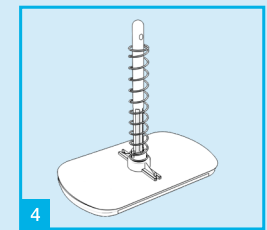

4 Once the diaphragm washer has been replaced, secure the clip and re-fit spring.

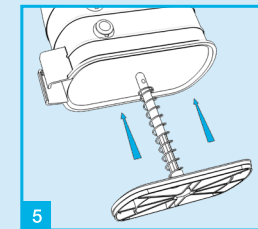

5 Slide the suction unit back through the base.

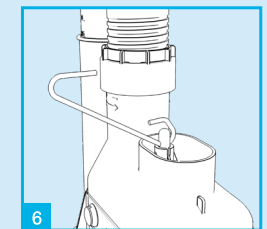

6 Re-connect the C link to the stem.



WARNING

If using the syphon with a ball valve, ensure it does not pool around the C link when it fills as this will disable the half flush mechanism.

