



THINKING PRECAST?
THINK FP MCCANN

GB EDITION

BUILDING SOLUTIONS

QUICK REFERENCE GUIDE

v2.0





FP McCann is the UK's market leader in the manufacture, supply and delivery of precast concrete solutions. Our comprehensive precast concrete business extends to include:

**AGRICULTURE | ARCHITECTURAL PRECAST
BOX CULVERTS | BUILDING PRODUCTS
DOCK LEVELLER PITS | DRAINAGE | FENCING
FILTER BED SYSTEMS | FLOORING
POWER & INFRASTRUCTURE | RAIL
SPECIALIST PRECAST | STRUCTURAL PRECAST
TANKS & CHAMBERS | TUNNELS & SHAFTS |
WALLING**

Please note: all information is correct at time of going to print.



FP McCann manufactures a wide range of high quality precast concrete products for the construction industry. All of our building products are manufactured to European standards.

CONTENTS

Lintels	4
Padstones	5
Pier Caps / Wall Copings / Gulley Surround	6
Slotted Posts	7
Gravel Boards / Deck Posts	8
Bollards / Universal Posts/ Repair Spurs	9
Beam and Block / Poly Flooring	10
Beam and Block Ancillaries	11
Thermabeam™	12
L Walls	13
Easi-Base™	14
Pipes	16
Manhole Chambers & Soakaways	18
Manhole Cover Slabs	20
Adjusting Corbels / Corbel Slabs	21
Catchpit	22
Valve Chamber	23
StormBrake™ Flow Control Chamber	24
Headwalls	25
Gullies and Slabs Range	26
BT Approved Comms Boxes	28
House Inspection Chambers	30
Box Culverts	31

PRESTRESSED CONCRETE LINTELS & PADSTONES

FP McCann's range of prestressed concrete lintels and padstones are designed to provide a low cost and resilient masonry support for door and window openings.

The prestressed casting system used to develop lintels ensures consistent high quality and a smooth finish providing safer manual handling. Our lintels and padstones are manufactured to European Standards.

LINTEL LOAD / SPAN TABLE

Service RM (kN/m)		100 x 65 Flat	100 x 65 Upright	140 x 65 Flat	140 x 65 Upright	140 x 100 Flat	100 x 140 Upright
		0.93	1.35	1.03	2.77	3.17	4.52
Length	Effective Length	UDL (kN/m)	UDL (kN/m)	UDL (kN/m)	UDL (kN/m)	UDL (kN/m)	UDL (kN/m)
450	n/a	82.35	120.43	91.72	245.91	281.55	401.73
600	450	36.60	53.52	40.77	109.29	125.13	178.55
750	600	20.59	30.11	22.93	61.48	70.39	100.43
900	750	13.18	19.27	14.68	39.35	45.05	64.28
1050	900	9.15	13.38	10.19	27.32	31.28	44.64
1200	1050	6.72	9.83	7.49	20.07	22.98	32.79
1350	1200	5.15	7.53	5.73	15.37	17.6	25.11
1500	1350	4.07	5.95	4.53	12.14	13.90	19.84
1650	1500	3.29	4.82	3.67	9.84	11.26	16.07
1800	1650	2.72	3.98	3.03	8.13	9.31	13.28
2100	1950	1.95	2.85	2.17	5.82	6.66	9.51
2400	2250	1.46	2.14	1.63	4.37	5.01	7.14
2700	2550	1.14	1.67	1.27	3.40	3.90	5.56
3000	2850	0.91	1.33	1.02	2.72	3.12	4.45
3300	3150	0.75	1.09			2.55	3.64
3600	3450	0.62	0.91			2.13	3.04

NOTES:

- Composite brickwork figures are not included in the above load span table
- Minimum 150mm clear spans, plus a sound bearing length of 150mm minimum at each end. Where required, suitable padstones should be used
- The Uniformly Distributed Loads (UDL) above are Serviceability Loads in kN/m and are based upon the least of the flexural strength, the shear strength or the load that provides a maximum deflection of L/325 Deflection information is available upon request
- Lintels tested in accordance with BS EN 845-2:2013 and BS EN 846-9:2016
- Part packs are available on request
- High strength lintels are also available

LINTEL SIZES / PACK SIZES

Key: **Weight (KG) Per Pack / Number Per Pack**

Length (mm)	Number & Weight per pack															
	100 x 65		140 x 100		140 x 65		100 x 100		215 x 100		215 x 65		140 x 140		215 x 140	
450	336	48	450	30	480	48	-	-	920	40	-	-	-	-	-	-
600	432	48	600	30	624	48	504	30	1520	40	612	30	806	28	-	-
750	576	48	750	30	768	48	648	30	1520	40	765	30	756	21	-	-
900	672	48	900	30	960	48	792	30	1840	40	918	30	907	21	932	14
1050	768	48	1050	30	1104	48	900	30	1428	40	1071	30	1058	21	1078	14
1200	912	48	1200	30	1248	48	1044	30	1632	40	1224	30	1210	21	1243	14
1350	336	16	450	10	464	16	384	10	680	10	459	10	454	7	-	-
1500	368	16	500	10	528	16	432	10	760	10	510	10	504	7	777	7
1650	416	16	550	10	576	16	480	10	830	10	561	10	554	7	-	-
1800	448	16	600	10	624	16	516	10	910	10	612	10	605	7	932	7
1950	480	16	650	10	672	16	-	-	990	10	-	-	-	-	-	-
2100	528	16	710	10	736	16	600	10	1060	10	714	10	706	7	1088	7
2250	560	16	760	10	784	16	-	-	1140	10	-	-	-	-	-	-
2400	592	16	810	10	832	16	696	10	1210	10	816	10	806	7	1243	7
2550	640	16	860	10	896	16	-	-	1290	10	-	-	-	-	-	-
2700	672	16	910	10	944	16	780	10	1370	10	-	-	907	7	1399	7
2800	-	-	940	10	-	-	-	-	-	-	-	-	-	-	-	-
2850	720	16	960	10	992	16	-	-	1440	10	-	-	-	-	-	-
3000	752	16	1010	10	1056	16	864	10	1520	10	-	-	1008	7	1554	7
3150	-	-	-	-	-	-	-	-	1590	10	-	-	-	-	-	-
3300	816	16	1110	10	-	-	-	-	1670	10	-	-	-	-	1709	7
3450	-	-	-	-	-	-	-	-	1740	10	-	-	-	-	-	-
3600	896	16	1210	10	-	-	-	-	1820	10	-	-	-	-	1865	7
3750	-	-	-	-	-	-	-	-	1900	10	-	-	-	-	-	-

PADSTONES

Padstone sizes (mm)	Pack sizes
215 x 140 x 100	24
215 x 215 x 100	24
300 x 100 x 140	24
300 x 100 x 215	24
330 x 215 x 100	24
380 x 140 x 215	24
440 x 140 x 100	24
440 x 140 x 140	24
440 x 215 x 100	24
440 x 215 x 140	24
440 x 215 x 215	24
600 x 140 x 100	24
600 x 215 x 100	24



Concrete lintel as used traditionally in construction.

Concrete lintel as used to bridge pipes underground.



Padstone

Special padstone sizes available on request

PIER CAPS, WALL COPINGS & GULLY SURROUND

PIER CAPS & WALL COPINGS

FP McCann's precast concrete wall copings and pier caps provide an eye-catching and economical finish to various wall designs. The high calibre of these products helps prevent potential wall erosion or discolouring caused by adverse weather conditions. Pier caps and wall copings are available in Saddleback. Standard finish only.

WALL COPING SIZES

Product Code/Description	Pack Sizes
Pre SB Coping 125x30x600mm**	140
Pre SB Coping 175x75x906mm**	36
Pre SB Coping 285x50x600mm**	50
Pre SB Coping 302x60x905mm**	24
Pre TW Coping 165x60x610mm**	60
Pre TW Coping 305x70x610mm**	30
Pre TW Coping 355x75x610mm**	30
Pre TW Coping 405x75x915mm**	15
Pre OW Coping 165x60x610mm*	60
Pre OW Coping 305x70x610mm*	32
Pre OW Coping 355x75x610mm**	30
Pre OW Coping 405x75x915mm*	15

* Once Weathered ** Twice Weathered
Special wall coping sizes available on request



Wall Coping

PIER CAP SIZES

Saddleback size	A	B	C	No. per pack
12"	300	40	70	30
16"	400	50	85	24
18"	450	50	100	16
22"	560	50	120	8

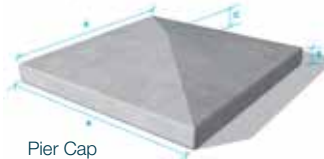

Pier Cap

All measurements are in mm .

GULLY SURROUND

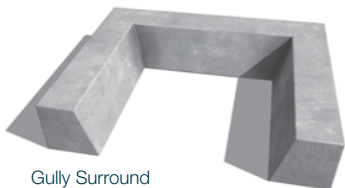

Gully Surround

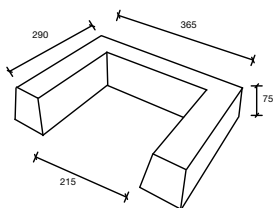

SLOTTED POSTS

With over 30 years' experience in the manufacture of precast concrete products, FP McCann offers a wide range of precast fencing solutions.

Product Code	Sizes (mm)	Sizes (ft)	No. per Tonne	No per Pack	Individual Weight (kg)	Pack Weight inc. Packaging (kg)
Slotted Posts - Intermediates						
FPSLP150	1525	5'	35.09	40	28.5	1160
FPSLP180	1830	6'	28.99	40	34.5	1400
FPSLP210	2135	7'	25.42	30	39.3	1200
FPSLP240	2440	8'	22.39	30	44.7	1360
FPSLP275	2745	9'	18.99	30	52.7	1600
FPSLP305 NEW	3050	10'	17.86	30	56.0	1700
Slotted Posts - Corners						
FPSLPC150	1525	5'	20.34	6	49.2	301
FPSLPC180	1830	6'	17.19	6	58.2	355
FPSLPC210	2135	7'	15.00	6	66.7	406
FPSLPC240	2440	8'	12.66	6	79.0	480
FPSLPC275	2745	9'	11.09	6	90.2	547
Slotted Posts - Ends						
FPSLPE150	1525	5'	32.47	10	30.8	328
FPSLPE180	1830	6'	26.46	10	37.8	398
FPSLPE210	2135	7'	22.57	10	44.3	463
FPSLPE240	2440	8'	20.12	10	49.7	517
FPSLPE275	2745	9'	17.83	10	56.1	581
FPSLPE305 NEW	3050	10'	15.87	10	63.0	1650



Heavy-duty and Heavy-duty lightweight slotted posts are also available. In addition, standard morticed and recessed posts are available.

All of the above products are also available in our Fenn-Lite lightweight range.

We also have standard chainlink and cranked top security posts in stock.

GRAVEL BOARDS & DECK POSTS

GRAVEL BOARDS

Product Code	Sizes (mm)	Sizes (in)	No. per Tonne	No. per Pack	Individual Weight (kg)	Pack Weight inc. Packaging (kg)
Gravel Boards For Slotted Posts						
FPGBP150 Plain	1830x150x45	6"	36.10	40	27.7	1120
FPGBP305 Plain	1830x305x45	12"	17.17	20	58.3	1180
FPGBR150 Recessed	1830x150x45	6"	37.56	40	26.6	1080
FPGBR305 Recessed	1830x305x45	12"	21.62	20	46.3	940
FPGBRF305 Rock Faced Semi dry	1830x305x45	12"	19.14	20	52.3	1060
FPGBRF305WC Rock Faced Wet cast	1830x305x45	12"	18.43	20	54.3	1100
FPGBRF305WCHP Rock Faced WC High profile	1830x305x45	12"	16.90	16	59.1	960

DECK POSTS

The FP McCann DeckPost is the durable precast solution for your decking requirements. Whether you plan to create an elevated decking area, or simply to level out irregular ground conditions, DeckPost is the obvious choice.

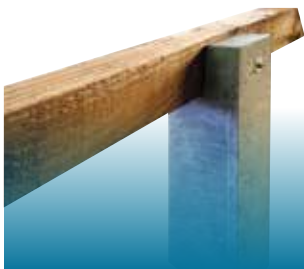

Product Code	Sizes in mm/in	No. per Tonne	No. per Pack	Individual Weight (kg)	Pack Weight inc. Packaging (kg)
PREFPDECP450	450x100x100/18x4x4	90.91	120	11.00	1340
PREFPDECP600	600x100x100/24x4x4	71.43	72	14.00	1028
PREFPDECP900	900x100x100/36x4x4	47.62	48	21.00	1028
PREFPDECP1200	1200x100x100/48x4x4	37.04	36	27.00	992

BOLLARDS, UNIVERSAL POSTS & REPAIR SPURS



Product Code	Sizes (mm)	Sizes (ft/in)	No. per Tonne	No. per Pack	Individual Weight (kg)	Pack Weight inc. Packaging (kg)
Universal Posts - Intermediate						
FPUNP150	1525	5'	27.99	36	35.7	1306
FPUNP180	1830	6'	23.08	36	43.3	1580
FPUNP210	2135	7'	19.85	27	50.4	1380
FPUNP240	2440	8'	16.88	27	59.3	1620
FPUNP275	2745	9'	15.88	27	63.0	1720
Repair Spurs 3x3						
FP SUPP 099 3X3	990	3' 3"	74.63	70	13.4	953
FP SUPP 105 3X3	1070	3' 6"	69.44	70	14.4	1023
Repair Spurs 4x3						
FPSUP090	915x100x75	3'	65.73	70	15.2	1080
FPSUP105	1070x100x75	3' 6"	57.14	70	17.5	1240
FPSUP120	1220x100x75	4'	49.82	70	20.1	1420
FPSUP135	1370x100x75	4' 6"	44.16	70	22.6	1600
Repair Spurs 4x4						
FPSUP0904X4	915x100x100	3'	50.56	60	19.8	1188
FPSUP1054X4	1070x100x100	3' 6"	43.90	60	22.8	1368
FPSUP1204X4	1220x100x100	4'	38.50	60	26.0	1560
FPSUP1354X4	1370x100x100	4' 6"	33.58	60	29.8	1788
Screed Rail						
FPSRBF050	50x3000	2"	85.46	104	11.7	1237
FPSRBF100	100x3000	4"	38.34	48	26.1	1272
FPSRBF125	125x3000	5"	26.74	33	37.4	1254
FPSRBF150	150x3000	6"	21.43	30	46.7	1420
Bollards						
FPBOL135	1370x225	4' 6"	10.96	5	91	475

Repair Spurs

Available in 4"x 4", 4"x 3" & 3"x 3"



Universal Posts

BEAM & BLOCK / POLY FLOORING



150MM DEEP T BEAM

Span Load Table - 150mm Deep T Beam		Finishes = 1.5kN/m ²					
		Superimposed load in kN/m ²					
Floor case (based on 1400kg/m ³ block density)	Floor self weight kN/m ²	1.5	2	2.5	3	4	5
150 DEEP T BEAM		Maximum clear span (m)					
Single beam - full block	1.78	4.30	4.10	3.90	3.74	3.46	3.24
Single beam - full block/narrow block, alternate	1.88	4.82	4.58	4.37	4.20	3.90	3.65
Single beam - narrow block	2.07	5.57	5.31	5.08	4.88	4.34	4.26

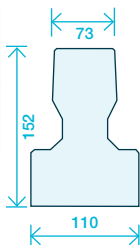

150MM DEEP WIDE BEAM

Span Load Table - 150mm Deep T Beam		Finishes = 1.5kN/m ²					
		Superimposed load in kN/m ²					
Floor case (based on 1400kg/m ³ block density)	Floor self weight kN/m ²	1.5	2	2.5	3	4	5
150 DEEP T BEAM		Maximum clear span (m)					
Single beam - full block	1.96	4.75	4.67	4.56	4.37	4.07	3.81
Single beam - full block/narrow block, alternate	2.10	5.07	4.99	4.90	4.80	4.51	4.24
Single beam - narrow block	2.33	5.48	5.40	5.30	5.25	5.10	4.83

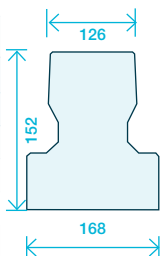

BEAM & POLYSTYRENE PANEL FLOORING

FP McCann offers a choice of two energy-efficient beam and polystyrene panel systems.



Top Sheet System

Our top sheet flooring system incorporates a polystyrene panel which sits within the depth of the floor beam, as well as including an over board top sheet to sit on top of the floor. U-values of 0.11 W/m²K or better can be achieved with our top sheet system.

Undercloaking System

We also supply an undercloaking system which incorporates one panel that fits within the floor beam depth, as well as falling beneath the level of the beam to allow for complete thermal coverage. U-values of 0.08 W/m²K or better can be achieved utilising the undercloaking system.

ANCILLARIES

Alongside our beam and block flooring solutions, we offer relevant ancillary products such as end slips, closure units, ceiling clips, vents and air bricks. These extras will be detailed on our quotation and shown as either an extra-over or an inclusion.

End Slip

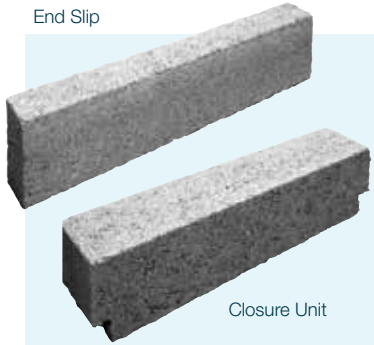

Closure Unit

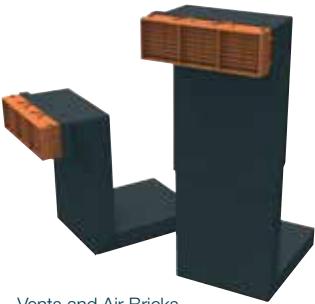

Vents and Air Bricks

BEAM AND BLOCK ADDITIONAL SERVICES

Supply & Fix

As well as offering products on a supply only basis, we also offer a supply and install service. Any contract undertaken on a supply and fix basis will include labour and plant, as necessary.

Transport

We have a range of delivery vehicles available including articulated vehicles, rear wheel steer trailers or rigid loads. Please contact us for further details.

Merchants

Beams are readily available for stock and can be supplied in standard lengths. Blocks are available on a supply and fix basis only. For further information on this, please contact us.

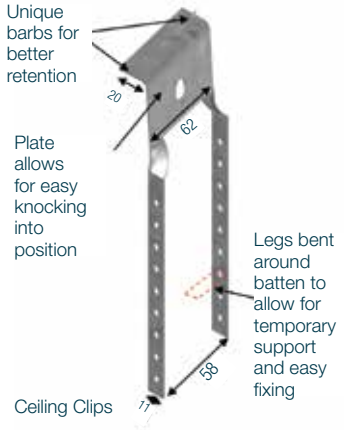

THERMABEAM™

THE INNOVATIVE ALTERNATIVE TO
BEAM AND BLOCK FLOORING

NEW
PRODUCT

WHAT IS THERMABEAM™?

Thermabeam™ is an insulated precast flooring system that combines both high performance expanded polystyrene (EPS) insulation and reinforced concrete, forming a continuous layer of insulation across the whole floor. The structural concrete is cast onto the insulation, eliminating air gaps, thereby minimising heat loss.



Thermabeam™ units are available in a standard depth of 300mm, each with a choice of two insulation types - poly or platinum poly. All Thermabeam™ units are grouted on-site using C25/30 sand cement mortar.

Thermabeam unit	Perimeter/Area Ratio	U-Value (W/m²K)
300mm	0.6	*0.14W/m²K

APPLICATIONS

Residential ground floors.

As well as offering excellent insulating properties, and a significant reduction in cold bridging, the Thermabeam™ system helps to reduce CO² emissions by decreasing the amount of non-renewable energy required to heat the building.

* Figures based on the Platinum Poly Insulation

300mm Thermabeam

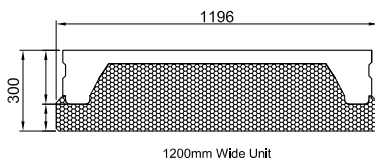

BENEFITS

- Low on-site costs and space required since units are manufactured off-site
- Fast installation, enabling a safe platform for follow-on trades within a few hours
- Excellent thermal performance due to its insulating properties. A reduction in cold bridging is achieved, resulting in better Psi (ψ) values
- U-Values as low as 0.14W/m² K, based on a P/A ratio of 0.6 can be achieved
- Helps building to achieve a higher energy-efficiency rating
- Reduced safety issues – reduced on-site working
- High quality units are designed in accordance with relevant BS EN standards: BS EN 1992-1-1:2004 (Eurocode 2: Design of concrete structures) and BS EN 13224:2001 (Precast Concrete Products – Ribbed Floor Elements)
- Low carbon footprint – since less energy is required to heat building
- Spans up to 6.5m (depending on load)

L WALLS



FP McCann's precast concrete L shaped retaining walls are ideal for a variety of applications, including earth retention works on new developments.

The speed of construction is a major benefit of the 'L' wall system and the off-site wet casting of the reinforced 'L' walls ensures a consistent factory finish. They can be secured to a concrete base by means of resin and steel dowel rods.

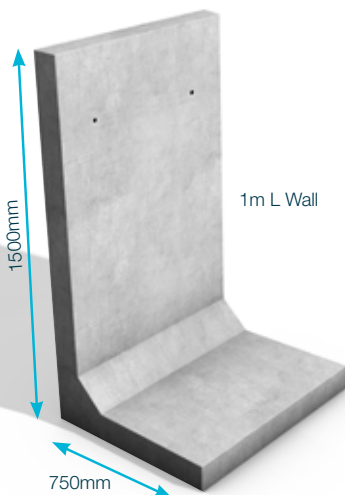

STANDARD L WALL SIZES

The loading 18 kN/m^3 is approximately a bulk density of 1800 kg/m^3

Height (mm)	Width (mm) straight unit	Weight (kg) straight unit	Width (mm) corner unit	Weight corner unit (kg)
1000	1000	440	1000 X 1000	790
1500	1000	710	1000 X 1000	1170
1750	1000	870	1000 X 1000	1390
2000	1000	1010	1000 X 1000	1580
2500	1000	1500	1250 X 1250	2950
3000	1000	1960	1500 x 1500 (2 Piece)	2350
3750	1000	2950	2310 x 2310 (4 Piece)	2780

(Include 5% lifting allowance)

EASI-BASE™



DN1200 EASI-BASE™

FP McCann's DN1200 Easi-Base™ is a prefabricated manhole base unit with integral benching, channels and connectors, that provides an immediate and long-lasting watertight solution in the management of waste water.

PRODUCT BENEFITS

- An extremely fast, efficient and economical method of constructing manhole bases on-site
- Accepted by all UK water companies
- Significant health and safety benefits
- An immediate watertight structure, allowing other trades to instantly follow on
- Factory prefabrication provides a quality finish to channelling and benching, and enables accurate combinations and variations for entry/exit pipes
- Connects with any type of pipe and is compatible with the DN1200 130mm thick wide wall chamber ring which eliminates the need for backfilling.
- Maintenance of channels and benches are aided by clean access for inspection
- Eliminates the risk of water pollution that is associated with traditional methods of manhole construction, such as concrete base formation integrity failures due to bad weather conditions, which results in groundwater being contaminated with polluted raw sewerage and clean groundwater infiltrating the already overloaded raw sewerage system of pipelines and treatment plants
- The 7th Edition of Sewers for adoption has now been published to include precast bases; Easi-Base™ units are in full accordance with the guidance provided
- An 80 year guaranteed base

DN1500 - DN3000 EASI-BASES™

FP McCann's bespoke Easi-Bases™ from DN1500 to DN3000 complement our existing manhole ranges and are produced as monolithic units, utilising standard manhole tongue and groove joints for connection with standard manhole chambers. These units are produced wholly from concrete and provide a variety of connection orientations using the Predl Clock System. They can accommodate concrete, clay, twinwall, ductile iron and uPVC pipes from 150mm to 1200mm.

DN1200 - DN3000 EASI-BASE™ UNIT SIZES

Diameter	Internal Diameter	Invert Level (for take off)	Depth	Weight
DN1200	150	370	520	1.7
DN1200	150	445	595	1.8
DN1200	150	520	670	1.9
DN1200	225	470	620	2.2
DN1200	225	545	695	2.4
DN1200	225	620	770	2.5
DN1200	300	520	670	2.4
DN1200	300	595	745	2.5
DN1200	300	670	820	2.7
DN1500	150	470	750	3.5
DN1500	225	545	750	3.5
DN1500	300	600	750	3.5
DN1500	375	705	1000	4.6
DN1500	450	810	1000	4.4
DN1500	525	920	1250	4.7
DN1500	600	1000	1250	4.75
DN1800	150	470	750	6
DN1800	225	545	750	6
DN1800	300	600	750	6
DN1800	375	705	1000	6.5
DN1800	450	810	1000	6.5
DN1800	525	920	1250	7
DN1800	600	1000	1250	6.5
DN1800	675	1150	1400	8
DN1800	750	1200	1500	7.75
DN1800	825	1300	1500	7.5
DN1800	900	1300	1500	6.75
DN2100*	†150 - 1200	1900	2436	Δ 10.5
DN2400*	150 - 1200	1900	2436	Δ 10.5
DN2400*	150 - 450	675	1175	Δ 7.8
DN2400*	525	775	1275	Δ 8.1
DN2400*	600	925	1425	Δ 8.5
DN2400*	675 - 825	1185	1685	Δ 7
DN2400*	900	1435	1935	Δ 7
DN2400*	1050	1685	2185	Δ 7.8
DN2400*	1200	1935	2435	Δ 8.5
DN2700*	150 - 450	675	1175	Δ 9.7
DN2700*	525	775	1275	Δ 10.1
DN2700*	600	925	1425	Δ 10.6
DN2700*	675 - 825	1185	1685	Δ 8.8
DN2700*	900	1435	1935	Δ 8.8
DN2700*	1050	1685	2185	Δ 9.7
DN2700*	1200	1935	2435	Δ 10.6
DN3000*	150 - 450	675	1175	Δ 10.8
DN3000*	525	775	1275	Δ 11.1
DN3000*	600	925	1425	Δ 12
DN3000*	675 - 825	1185	1685	Δ 9.6
DN3000*	900	1435	1935	Δ 9.6
DN3000*	1050	1685	2185	Δ 10.8
DN3000*	1200	1935	2435	Δ 12

All sizes are in mm

* 2 part unit / max Δ per unit
† 1 unit ex Knockloughrim depot

PRODUCT QUALITY

- Easi-Base™ is a Kitemark product, manufactured and tested to BS EN 1917
- WRc tested and approved
- Easi-Base™ is accepted for use by all major UK water companies

SEALANT

DN1200	12mm x 120mm x 4.2m
DN1500	12mm x 120mm x 5.2m
DN1800/DN2100	12mm x 120mm x 6.0m

PIPES



All of our spigot and socket pipes are manufactured and CE marked in accordance with European Standard BS EN 1916, the specification for unreinforced and reinforced concrete pipes (including jacking pipes) and fittings with flexible joints. They are also designed to meet BS 5911 for concrete pipes and ancillary products. We also stock rocker pipes, as well as one piece, two piece and three piece bends.

Nominal Size	DN	300	375	450	525	600	675
Internal Diameter	A	300	375	450	525	600	675
Barrel Diameter	B	416	505	590	685	790	901
Socket Diameter	C	497	575	665	760	852	960
Effective Length	MM	2500	2500	2500	2500	2500	2500
Actual Weight	KG	454	616	812	996	1420	1856
Reinforced		N	N	N	N	N	N
Approx. Pipes per load		61	45	34	28	22	15
Chamber Ring to suit †		1200	1350	1350	1500	1500	1500
MOL Availability		Y	Y	Y	Y	Y	N
Crushing Strengths	Kn/M	36	45	54	63	72	81
Nominal Joint Gap	MM	4	4	4	4	4	4
Maximum Joint Gap	MM	34	34	34	34	34	34
Maximum Deflection	°Degrees	2	2	2	2	2	2

† Minimum chamber ring size to suit pipe = DN size of pipe + 900

ONE PIECE INTEGRAL RUBBER SEAL





Rocker Pipe



Socket Butt Pipes

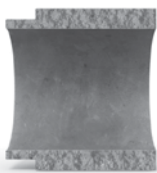

Spigot Butt Pipes

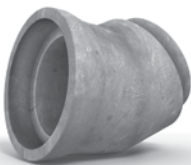

Two Piece Bend

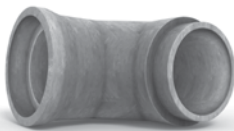

Three Piece Bend

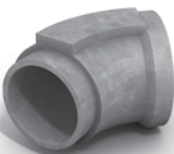

One Piece Bend



750	825	900	1050	1200	*1350	*1500	*1800	*2100	*2400
750	^805	900	1050	1200	1350	1500	1800	2100	^2380
996	975	1080	1266	1460	1620	1800	2130	2460	2750
1060	1130	1235	1420	1590	1800	2010	2380	2650	2750
2500	2500	2500	2500	2500	2500	2500	2500	2500	2500
2194	1690	2060	2760	3630	4290	5330	7300	9160	10070
N	Y	Y	Y	Y	Y	Y	Y	Y	Y
12	17	13	10	8	6	5	4	3	2
1800	1800	1800	2100	2100	2400	2400	2700	3000	3600
N	N	N	N	N	N	N	N	N	N
90	99	108	126	144	162	180	216	252	288
4	4	4	5	5	5	7	7	7	-
34	34	34	34	36	36	36	41	41	-
1	1	1	1	1	0.5	0.5	0.5	0.5	-

* Lifting anchors available ^ Please note internal dimensions



FP McCann now provide a new type of integral seal for their precast concrete pipes. This new integrated seal is a simple, one-piece rubber compression connector which is embedded in the concrete when the pipe is cast. The seal is compressed between the pipe and the concrete, creating a flexible watertight seal.

MANHOLE CHAMBERS/ SOAKAWAYS



MANHOLE CHAMBERS (TONGUE & GROOVE JOINT)

Nominal Size (A) (DN)(mm)	Available Depth of Section (D)				Wall Thickness (C) mm
	250mm (±25mm)	500mm (±25mm)	750mm (±50mm)	1000mm (±50mm)	
900	✓	✓	✓	✓	70
1050	✓	✓	✓	✓	80
1200	✓	✓	✓	✓	90
1350		✓	✓	✓	95
1500		✓	✓	✓	100
1800		✓	✓	✓	115
2100		✓	✓	✓	125
2400		✓	✓	✓	140
2700		✓	✓	✓	150
3000		✓	✓	✓	190
3600		✓	✓	✓	185
4000			✓	✓	200

MOL from 900-1500 / * 2 piece chamber ring - 3600kg per piece

△ 570 long wavy tail anchors

PRODUCT INFORMATION

- FP McCann's manhole chamber rings are manufactured with tongue and groove joints and comply with BS EN 1917 / BS 5911-3
- Manhole chambers from DN900 -DN1800 have 3 lifting points
- Manhole chambers from DN2100 - DN3000 have 4 lifting points
- DN3600 and DN4000 are outside of the scope of the British Standard (Non-Kitemark), but comply with all relevant provisions of the European Standard. DN4000 is supplied in two halves

NB: NI have 3 lifting points

WIDE WALL MANHOLE CHAMBERS

Nominal Size DN (mm)	250mm (±25mm)	500mm (±25mm)	750mm (±50mm)	1000mm (±50mm)	Wall Thickness (mm)
1200	✓	✓	✓	✓	130
1500	✓	✓	✓	✓	130
1800	✓	✓	✓	✓	130

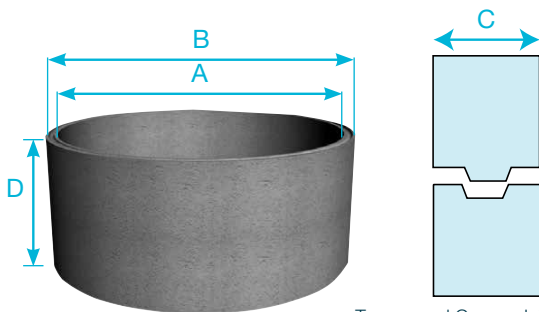

Tongue and Groove Joint Profile

Litres per metre	Barrel Diameter (B) (mm)	Approx Weight Kg. (per metre)	Approx. Products per load Qty. (metre)	Lifting Hole Qty/Dia. (per /unit) (mm)
656	1040	520	38	3 x 45
894	1210	690	34	3 x 45
1167	1380	880	26	3 x 45
1478	1540	1050	22	3 x 45
1824	1710	1300	16	3 x 45
2544	2030	1750	12	3 x 45
3464	2350	2040	10	4 x 50
4514	2680	2790	8	4 x 50
5725	3000	† 3400	8	4 x 50
7069	3380	† 4700	5	4 x 50
10179	3970	5400	5	△ 3 x RD30
12566	4400	*7200	4	△ 4 x RD36

Dia ± 5mm

MANHOLE SOAKAWAY CHAMBERS

Nominal Size DN (mm)	No. of 75mm holes per chamber			Wall Thickness mm	Litres per metre ring	Barrel Dia. mm	Approx Weight Kg. (p/metre)	Approx. Products per load Qty. (metre)
	500 mm	750 mm	1000 mm					
900	5	8	10	70	656	1040	520	46
1050	6	9	12	80	894	1210	690	34
1200	7	10	14	90	1167	1380	880	26
1350	8	11	15	95	1478	1540	1050	22
1500	8	13	17	100	1824	1710	1300	18
1800	10	15	20	115	2544	2030	1750	12
2100	12	18	24	125	3464	2350	2040	10
2400	14	20	27	140	4514	2680	2790	8
2700	15	23	31	150	5725	3000	† 3400	6
3000	17	25	34	190	7069	3380	† 4700	5
*3600	20	31	41	185	10179	3970	5400	5
*4000	23	34	45	200	12566	4400	6800	1.5

Barrel Diameter (mm)	Approx Weight Kg. (p/metre)	Approx. Products per load Qty. (metre)	36mm Lifting Pin 0.7t SWL	42mm Lifting Pin 3.5t SWL	3 leg lifting chain SWL 3.1t
1460	1520	16	Lifting clutches. FP McCann		✓
1760	1645	14	supply recommended and		✓
2060	1970	12	approved lifting clutches.		✓

MANHOLE COVER SLABS

COVER SLABS

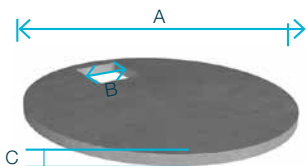

REDUCING SLABS

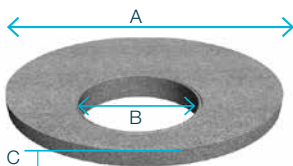

Chamber DN (mm)	Outside Diameter (A) (mm)	Slab Thickness (C) (mm)	STANDARD COVER SLABS			STANDARD REDUCING SLABS				
			Opening Configuration B		Approx. Weight (kg)	Opening Diameter B (mm)	Effective Depth (mm)	Approx. Weight (kg)		
			Size (mm)	Location						
900	1080	150	600x600	CENTRAL	215					
			675x675							
1050	1240	150	600x600	ECCENTRIC	315					
			675x675							
			750x750	CENTRAL						
1200	1450	150	600x600	ECCENTRIC	455	900	200	385		
			675x675							
			750x600							
1350	1580	170	600x600	ECCENTRIC	650	1050	200	695		
			675x675							
			750x600							
			1200x675	CENTRAL						
1500	1740	175	600x600	ECCENTRIC	980	900	200	981		
			675x675							
			750x600							
			1200x675	CENTRAL						
1800	2070	175	600x600	ECCENTRIC	1460	900	200	1495		
			675x675							
			750x600							
			1200x675							
2100	2380	200	600x600	ECCENTRIC	2180	900	200	2130		
			675x675							
			750x600							
			1200x675							
2400	2710	200	600x600	ECCENTRIC	2800	900	200	2815		
			675x675							
			750x600							
			1200x675							
2700	3030	230	600x600	ECCENTRIC	3750	900	200	3695		
			675x675							
			750x600							
			1200x675							
3000	3420	200	600x600	ECCENTRIC	4970	900	200	4970		
			675x675							
			750x600							
			1200x675							
*3600 Two Piece	4000	300	600x600	ECCENTRIC	9250			Covers to suit Manholes greater than or equal to 1.5m deep cover level to pipe soffit.		
*4000 Two Piece			4500						300	675x675
										750x600
										1200x675
	600x600	ECCENTRIC		11700			*3600mm and 4000mm diameter cover slabs come in a 2 piece unit			
675x675										
750x600										
1200x675										

Note:

Cover Slab sizes 900-3000 are manufactured in accordance with BS 5911-3. DN3600 and 4000 cover slabs are generally designed in accordance with BS EN 1992-1-1, (for 30 units of Type HB loading, can also be designed to withstand 45 units of Type HB loading).

* Weights for DN3600 and DN4000 are estimated weights based on solid slabs.

ADJUSTING UNITS & CORBEL SLABS

FP McCann manufactures a full range of adjusting units and corbel slabs that have the following advantages:

- Designed as seating for manhole cover
- Eliminates laying engineering bricks on-site
- Quicker to lay, ensuring reduced labour costs
- 65mm thick – similar to brickwork
- Sits on top of the manhole cover slab
- Eliminates brickwork vertical joint weakspots
- Quality product produced by vibration process
- Comprehensive strength, similar to Class B.Eng bricks

Type 2 600x600

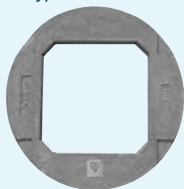

Type 2 675x675

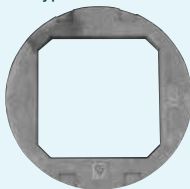

Type 2 750x600



Type 2 750x750



Type 2 1200x675

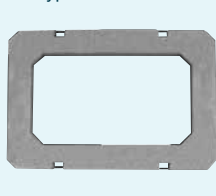

Type 1 600x600
Eccentric (Corbel)



Manhole Type	Diameter (mm)	Opening Size (mm)	No. per Pack	Thickness (mm)	Weight (kg)
Type 2	1050	600 x 600	15	65	70
Type 2	1050	675 x 675	15	65	55
Type 2	1050	750 x 600	15	65	60
Type 2	1050	750 x 750	10	65	45
Type 2	1575 x 1050	1200 x 675	6	75	160
Type 1	1175 x 1025	600 x 600	10	65	125

Note: A 600 x 600 eccentric corbel slab is also available when using a ladder BS EN 1917 and BS 5911

LOTHIAN SLAB

Size (A) (mm)	Slab Thickness (C) (mm)	Openings (B) (mm)	Approx. Weight (kg)
1125x1125	75	600x600	140
		675x675	
		750x600	
1125x1125	150	600x600	290
		675x675	
		750x600	

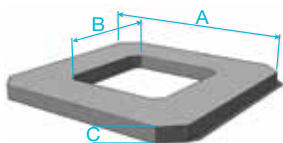

CATCHPIT

The catchpit effectively provides a sealed sump manhole, a monolithic precast concrete unit fitted with connector seals, which can be used to connect to the following types of pipe: uPVC, twinwall, clay, ductile iron and concrete. The catchpit is designed to accommodate pipe sizes DN150 to DN1800 and is in line with highway specification.

PRODUCT BENEFITS

- Creates an immediate watertight structure
- Prefabricated off-site (minimising on-site labour and costs)
- Quick and efficient to install
- Accommodates connection to all types of pipe used in road and manhole construction
- Safety benefits gained in the construction of manholes as the pre-formed sump and connect seals eliminate on-site construction, thus greatly reducing labour activity within the manhole
- Quality is greatly increased as construction is within the factory environment and complies with BS EN 1917 and BS 5911
- Eliminates material wastage associated with current in-situ method
- Yields environmental benefits such as lower carbon footprint, less concrete used on-site and less excavated material removed from site
- Bespoke designs available



Nominal Size (dn)	Height (mm)	+ Max. Pipe Size (mm)	Chamber OD (mm)	Wall Thickness (mm)	Capacity (l)
DN1050	* 1000	300	1210	80	650
DN1200	* 1000	300	1380	90	870
DN1500T1	* 1400	600	1800	150	1800
DN1500T2	* 2400	675	1800	150	3300
DN1800T1	* 1500	600	2100	150	2700
DN1800T2	* 2400	900	2100	150	5100
DN2100	* 2400	1350	2400	150	7000
DN2400	* 2700	1800	2700	150	10,500

* Height can be reduced to suit customers' requirements Based on 300mm sump. If a non-standard invert level is required, please specify when ordering
 ^ Lightweight catchpits (available on request)

VALVE CHAMBER

FP McCann designs and manufactures a bespoke range of reinforced valve chambers capable of housing any size and type of valve/pump. Valve chambers consist of a precast concrete sealed sump manhole with factory-fitted saddles to house the pump, and are used in the management of water, oils and chemicals.

Chamber Diameter	1200 - 3000mm
Chamber Height	900mm
Stool	Bespoke to project requirements
Pipe Size	150 - 375mm
Inlets / Outlets	Will vary to accommodate pipe size
Cover Slab Thickness	Will vary in accordance with chamber diameter
Base Thickness	250mm

PRODUCT BENEFITS

- Immediate watertight structure
- Reduced installation time/costs
- Accommodates connection to all types of pipe, including concrete, metallic, HDPE and clay
- Pump is raised off the ground and sits on a preformed concrete stool
- Easy and clean access for operation and inspection



**Approx. Weight (kg)		No. of Units per Load	Lifting Hole Qty/ da/ per unit
	1380	19	3no. ø45 lifting holes
	1600	16	3no. ø16 sockets and loops
	4700	5	3no. utility anchors
	7700	4	3no. utility anchors
	^ 6300	4	3no. utility anchors
	8300	3	3no. utility anchors
^ 9000	11000	3	3no. utility anchors
^ 11700	14000	2	3no. utility anchors

** Maximum weight of a solid, full height unit with no holes

+ Based on a standard catchpit only. If larger pipe sizes are required, please contact FP McCann

STORMBRAKE™

A NEW FORCE IN VORTEX FLOW TECHNOLOGY



Vortex Flow Controls are commonly used in drainage schemes to regulate the stormwater runoff from urban areas. Through the use of vortex flow technology, FP McCann's StormBrake™ provides a solution to a variety of stormwater management problems. These include accurately controlling stormwater flow, minimising upstream storage requirements and reducing the risk of blockages compared to traditional orifice plates.

FP McCann's StormBrake™ flow control chamber combines an integral base and side walls with provision for inlet and outlet connections.

It can be used in a number of applications, including:

- As a silt-trap
- As a valve chamber
- As a flow rate controller (requires installation of FP McCann's StormBrake™ flow control device, sold separately)

PRODUCT BENEFITS

- Minimal maintenance required after installation. FP McCann's StormBrake™ is self-activating and functions without any mechanical components
- Outlet areas of up to 6 times larger than an equivalent orifice plate, significantly reducing the risk of blockages and the associated maintenance costs
- Reduces the amount of upstream storage required, minimising the cost of providing attenuation facilities
- Accurately designed to meet a wide range of design conditions. For design conditions outside of this range, please contact FP McCann directly
- Contains a bypass door which can be manually opened at ground level using a pull cable to allow easy access for inspection or blockage removal
- Provides minimal flow restriction at low upstream heads to allow fast discharge of water during the initial stages of a storm



Low water level in the flow control chamber

HEADWALLS



FP McCann's precast concrete headwalls provide an ideal end connection point to outfall pipes into open watercourses such as rivers, culverts, collection and balancing ponds. They are a very efficient alternative to intrusive shuttering of soil embankments and costly on-site formwork with ready-mixed concrete, making them particularly suitable for use in hard-to-reach locations and in environmentally sensitive areas.

PRODUCT BENEFITS

- Headwalls are designed to EC2 and manufactured to BS EN 13369. (Full design calculations available to illustrate design assumptions).
- Prefabricated off-site
- Speedy and efficient to install
- Durable, long-lasting and low maintenance
- No on-site shuttering or formwork required
- Provides immediate stability and reduces soil erosion
- Cost-effective solution



Headwall Range	Up to & including Pipe Sizes	Max Pipe O.D. mm	Approx. Weight (Kg)
HW Small 100	300	450	1100
HW Small 150	300	450	1390
HW Medium 100	450	630	1540
HW Medium 150	450	630	2020
HW Large 100	900	1080	3020
HW Large 200	900	1080	4740
HW XL-T1	1500	1800	Part A / B 4725
HW XL-T2	1050	1260	Part A / B 4095
HW XL-T3	675	885	Part A / B 3465
HW XL-T4	375	505	Part A / B 2646
HW XXL-T1	2100	2460	Part A / B 10,150
HW XXL-T2	1500	1800	Part A / B 9205
HW XXL-T3	1050	1260	Part A / B 8421
HW XXL-T4	525	675	Part A / B 6915

GULLIES & SLABS RANGE

GULLIES

FP McCann provides an extensive range of gullies and gully cover slabs. Our road gullies and gully cover slabs are manufactured in accordance with BS 5911-6. Our precast concrete gullies are extremely robust and ideal for both domestic and heavy duty use.

Dimensions (mm)			Nominal Weight (Kg)	Approx. Capacity (litres)	No. per load
Diameter Internal	Depth	Outlet			
375	750	150	180	51	66
375	900	150	200	67	66
450	750	150	215	71	60
450	900	150	255	95	60
450	1050	150	270	118	60
450	1200	150	280	142	60



Gully

PRODUCT BENEFITS

- The seal has been cast-in, thus preventing loss or damage on-site
- An integral seal and rodding eye for universal sealing characteristics
- The rodding eye closure has been recessed into the concrete to help eliminate dislodgment
- Reduced thickness, giving reduced weight and a smaller footprint for better vehicle utilisation
- Improved system that helps prevent any discharge of oil
- The gully is fully universal, suitable for all plastic and clay drainage products from 160mm to 186mm diameter
- Does not lose shape
- Does not float (self weight inhibits flotation)

GULLY COVER SLABS



STANDARD GULLY COVER

HORSESHOE GULLY COVER

Dimensions (mm)	Standard		Horseshoe	
Length (A)	750		600	
Width (B)	650		650	
Thickness (C)	100		100	
Weight (kg)	70		58	
Hole Size (D)	375	450	375	450
Qty/Pack	12		12	

The Gully Cover Slab is designed as seating for a gully grate

PRODUCT BENEFITS

- Quicker to lay, ensuring reduced labour costs
- Use on top of 450mm diameter gully
- Eliminates laying engineering bricks on-site
- Sits flush to kerb for enhanced stability
- 100mm thick single piece unit
- Eliminates brickwork vertical joint 'weakspots'
- Greater stability than brickwork
- Quality product produced by vibration process
- Compressive strength similar to Class B.Eng. bricks

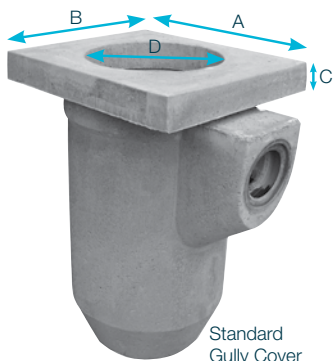

BT COMMS BOXES

Unique cable and junction protection boxes are made from reinforced concrete and can be installed in minutes, with the one piece construction design providing easy access for cable jointing and maintenance.

Communications boxes are mainly used in infrastructure works to include airports, railway projects, roads and housing developments. Cable pit chambers and other units for street lighting are also available in different sizes.

FEATURES

- Reinforced concrete walls
- Integrated reinforced base*
- Base incorporating sump*
- Splayed base to aid stability*
- Preformed cable entry points
- Easily manoeuvred with lifting eyes
- Ironmongery fitted^
- Suitable for up to 30 units HB loading
- Plastic encapsulated steps fitted*^
- Complementary lids are available from good Builders Merchants
- Bespoke duct arrangements available on request

* Comms J4 has no base, sump or steps

^ Comms DP has no ironmongery or steps fitted

COMMS 600

Length (mm)	Width (mm)	Height (mm)	Weight (kg)
600	600	750	806



COMMS C2

Length (mm)	Width (mm)	Height (mm)	Weight (kg)
1200	600	895	1440



COMMS J4

Length (mm)	Width (mm)	Height (mm)	Weight (kg)
910	440	800	590



COMMS DP

Length (mm)	Width (mm)	Height (mm)	Weight (kg)
910	890	1000	1390

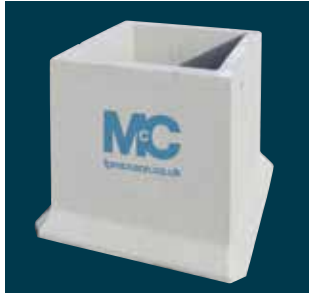

COMMS MCX

EXTRA FEATURES

- Highway construction details MCX compliant
- *Complementary reinforced concrete riser and cover slab are available from FP McCann



Dimensions	Length (mm)	Width (mm)	Height (mm)	Weight (kg)
Chamber	1300	850	900	2100
Riser	1300	850	300	300
Concrete Cover Slab*	1570	1120	150	300

HOUSE INSPECTION CHAMBERS

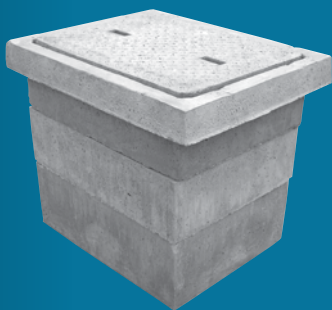

FP McCann's precast concrete inspection chambers are available in four sizes and are manufactured in accordance with BS EN 1917/ BS5911. Each section has a tongue and groove joint and can be sealed with a sand and cement mortar or bitumen sealant.

The precast concrete frame (also known as a surround) and lid combination is designed to sit flush with the top course, such as tarmac or concrete surfacing or in grassy areas.

The lid features an anti-slip chequered finish and recessed lifting points to allow removal from the frame by use of standard lifting eyes.

Description Units (mm)	**Weight per unit (mm)	No. of units per pallet	Wall/Slab thickness (mm)
600x450x150 section	40	12	40
600x450x225 section	65	8	40
600x450x300 section	85	6	40
600x450x100 frame	45	8	100
600x450x55 lid	50	16	55
750x600x150 section	60	6	55
750x600x250 section	100	4	55
750x600x70 cover slab (600x450 access)	75	8	*70
1000x675x150 section	94	6	60
1000x675x250 section	130	4	60
1000x675x76 cover slab (600x450 access)	130	8	*75
1200x750x150 section	120	6	75
1200x750x250 section	200	4	75
1200x750x80 cover slab (600x600 access)	185	6	*80

* Effective thickness ** Approximate weights

BOX CULVERTS



Designed and manufactured in accordance with all current design specifications and relevant standards, FP McCann's box culverts are available in span sizes from 1000mm to 6000mm and internal heights from 500mm to 3600mm. With our extensive range of moulds, we also strive to accommodate non-standard variances, along with any other internal features requested by the client.

BOX CULVERT APPLICATIONS

- Attenuation and storage tanks
- Water course diversion
- Open channels
- Road crossings
- Pedestrian and vehicle subways
- Shafts
- Service tunnels and ducts
- Conveyor protection

EASE OF INSTALLATION

FP McCann's box culverts can be easily positioned in shallow or deep fill installations.

STRUCTURAL STRENGTH AND LONG LIFE PERFORMANCE

Our durable box culvert system meets the design life requirements for buried structures. Minimum maintenance is required.

FLEXIBLE SIZES AND INTERNAL FEATURES

Our box culverts can be manufactured in a range of sizes and accommodate features such as dry weather flow channels, mammal ledges and tapered and skewed units, if required.



Box culvert with wing walls



CADEBY OFFICE:

Brascote Lane
Nuneaton Cadeby
Warwickshire
CV13 0BB

T 01455 290780 | sales@fpmccann.co.uk

AGRICULTURE

Lydney 01594 847500 Grantham 01476 562277

ARCHITECTURAL PRECAST

London 020 3905 7640

BOX CULVERTS

Weston Underwood 01335 361269

BUILDING PRODUCTS

Cadeby 01455 290780

DOCK LEVELLER PITS

Weston Underwood 01335 361269

DRAINAGE

Ellistown 01530 240000 (England/Wales) Magherafelt 028 7954 9026
(Scotland/NI)

FENCING

Cadeby 01455 290780

FILTER BED SYSTEMS

Wellesbourne 01789 336960

FLOORING

Weston Underwood 01335 361269 Uddingston 01698 803300

POWER & INFRASTRUCTURE

Littleport 01353 861416

RAIL

Littleport 01353 861416

SPECIALIST PRECAST

Littleport 01353 861416

STRUCTURAL PRECAST

Byley 01606 843500 Grantham 01476 562277

TANKS & CHAMBERS

Wellesbourne 01789 336960

TUNNELS & SHAFTS

Cadeby 01455 290780

WALLING

Grantham 01476 562277 Lydney 01594 847500
Uddingston 01698 803 300 (Scotland) Magherafelt 028 7954 9026 (NI)